

THIS INSTRUCTION BOOKLET CONTAINS
IMPORTANT SAFETY INFORMATION, PLEASE
READ AND KEEP FOR FUTURE REFERENCE.

Lot Number: _____

Date: _____

PART NO: 63607067

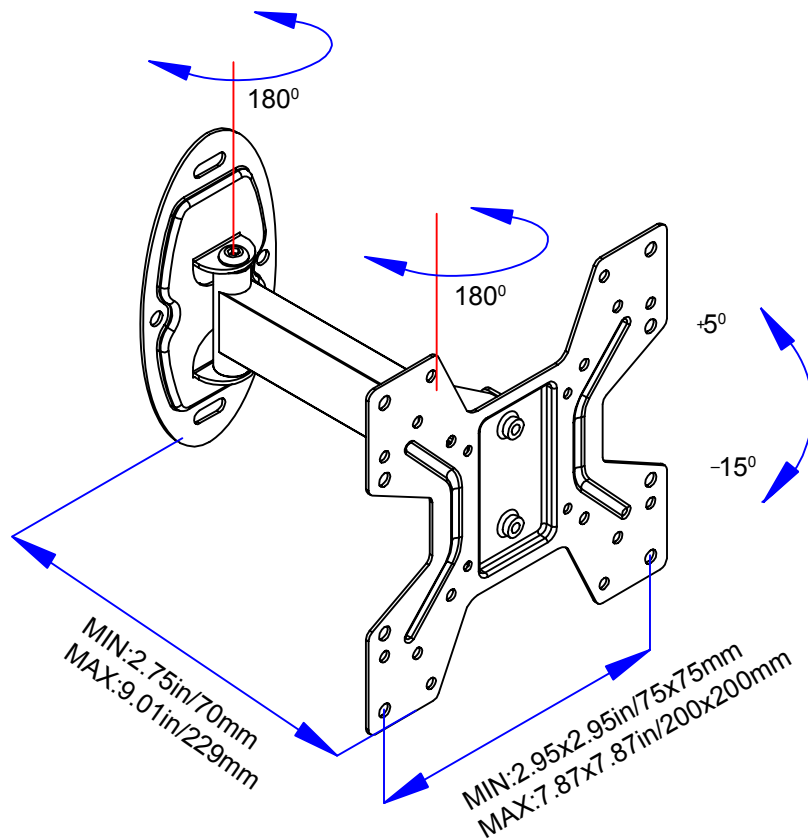

Product Warranty: Atlantic Inc., warrants to the original purchaser that its products are free from defect in materials or workmanship. If after inspection, we find that the product was defective in materials or workmanship, we shall repair or replace the product at our discretion. This warranty does not cover accidental damage, misuse, improper care or alteration and excludes claims for incidental or consequential loss. This limited warranty applies to product purchased in the U.S. and Canada. This warranty gives you specific legal rights and you may also have other rights which vary from State to State. This warranty duration will be last one year.

Keep this Instruction Manual for future reference.

Keep your original proof of purchase (store receipt).

If parts are missing, DO NOT return to the store.

To order missing / replacement parts or for assembly assistance please contact customer_relations@atlantic-inc.com.

Or call 1-800-747-2660 M-Th, 8am-5pm, Fri, 8am-12pm, P.S.T.

Assembly Tips:

Become familiar with the instructions and all parts.

Make sure that all parts are in the box and in good condition.

Assemble the product on the open flat carton or a rug to protect the product and your floor.

Some heavy products need a second person to assist in the assembly.

Do not install on the sloping surface.

With each step, first insert and hand-tighten all bolts and screws by hand. After **ALL BOLTS** are slightly screwed in, fully tighten bolts with Phillips screwdriver in sequential pattern (clockwise or counter clockwise).



Caution:

Never let children climb on product or play with product.

Do not sit or stand on product.

Do not fasten a TV that is heavier than the recommended load rating to the mount.

Improper installation may cause property damage and/or personal injury, so the installation must be done by two qualified contractors. The manufacture is not liable for damage or injury caused by incorrect mounting, assembly or use.

The unit will hold 10-37in(25.40-93.98cm) Plasma and LCD TV and the weight of TV must not exceed 66 lbs(30kgs). The wall must be capable of supporting five times weight of TV plus the mount.





Improper handling can result in cuts and lacerations.

Pictures for reference only, subject to our available products.

Care Instructions:

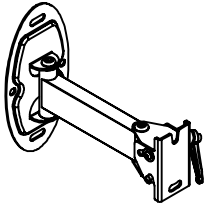
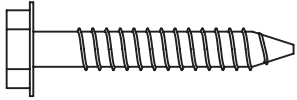
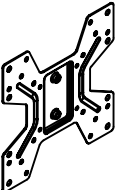
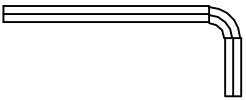
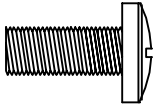
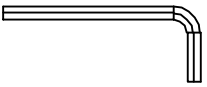
Use electrostatic dust cloths to clean product.

Parts List

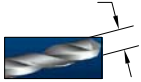
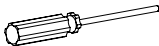
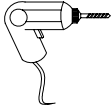
Item	Components Parts List	Q'ty	Item	Components Parts List	Q'ty
A		1	E		4
B		1	F		1
C		2	G		1
D		4			
Tools Needed(Not Included)					
     <p style="text-align: center;">$\varnothing 5/16"$ or 8mm Diameter Drill Bit</p>					

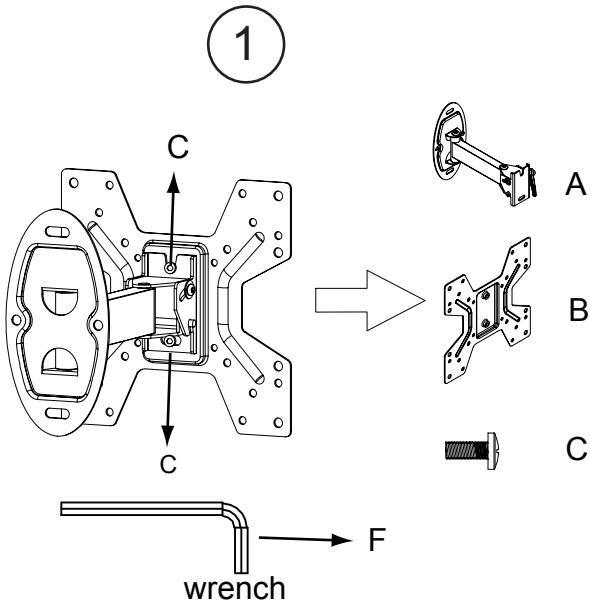

1. Remove TV plate(B) from wall bracket(A).

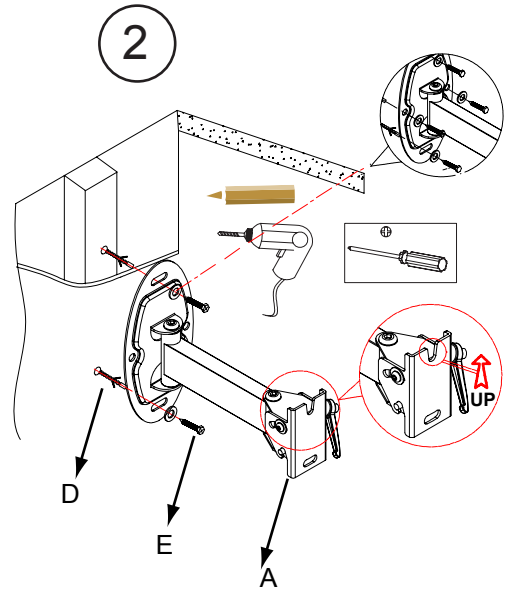

2. Hold wall bracket(A) against wall at desired position, then using a pencil mark 4 hole locations. Then drill holes according pencil marks using 5/16" or 8mm size drill bit to a depth of 2.5"/64mm. If you mount TV mount into studs, fix wall bracket(A) to wall with screws (E). If you are not mounting into studs, then you will need to use wall anchors (D). Insert wall anchors (D) into holes, you may need to use hammer to lightly tap wall anchors into wall. Then fix wall plate (A) to the wall with screws (E).

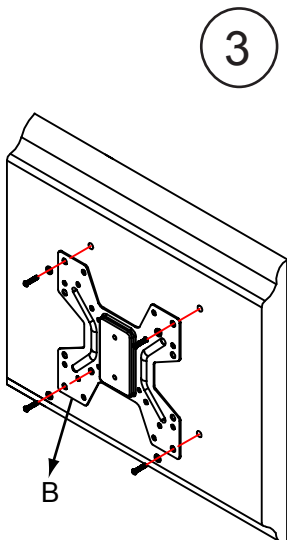

3. Attach TV plate(B) to the back panel of TV.

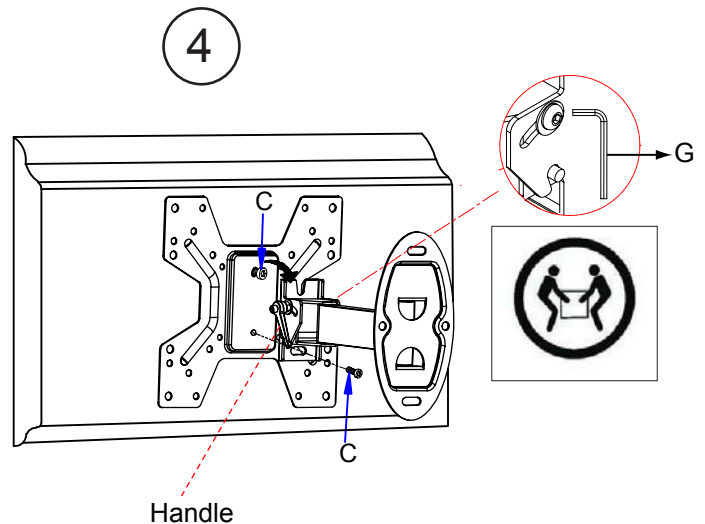



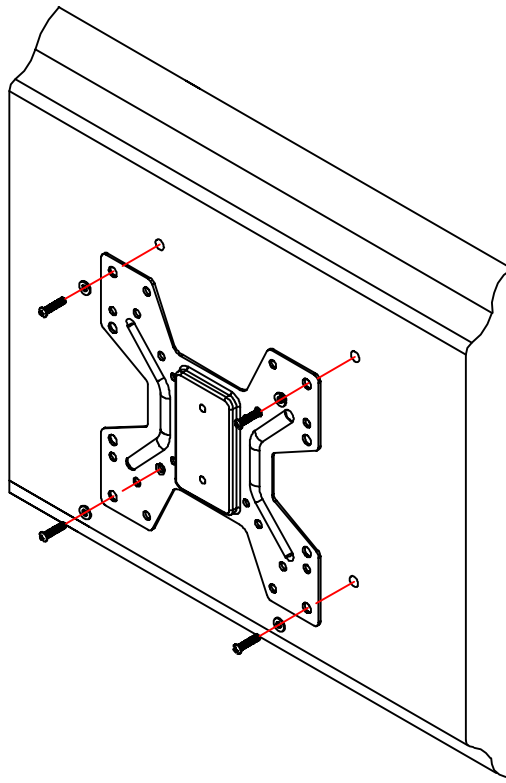









4. Attach the TV to wall bracket(A) with screws(C). You may need rotate the handle to adjust TV to your desired angle, please remember to fasten the screw tightly after adjustment



PAY EXTRA CARE AND ATTENTION WHEN YOU FASTEN TWO TV MOUNTS TO THE BACK PANEL OF TV IN **STEP 3**. MAKE SURE THE APPROPRIATE MOUNT HARDWARE IS BEING USED PROPERLY.

1. Select correct Mounting Hardware according to the screw hole size of your TV, discard any remaining screws or spacers.
2. Carefully lay your TV on its face on a non-abrasive surface, making sure to lay padding underneath it so as not to damage the screen.
3. Place left TV mount and right mount in the appropriate position, making sure **CENTERED** on the back of the TV and **LEVEL** with on another.

Mounting Hardware List		Q'ty	Mounting Hardware List		Q'ty
H	 M8X16	4	P	 M4/M5 washer	4
I	 M6X12	4	Q	 M6/M8 washer	4
J	 M5X12	4	R	 M8/M6 spacer	4
K	 M4X12	4	S	 M4/M5 spacer	4
L	 M8X40	4			
M	 M6X35	4			
N	 M5X30	4			
O	 M4X30	4			