

Assembly Instructions

Mode d'assemblage

Swivel Multimedia Storage Tower

Tour de rangement rotative pour multimedia

Séries # __MS-1060

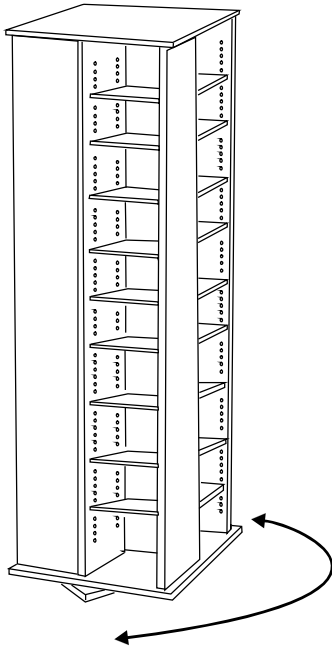

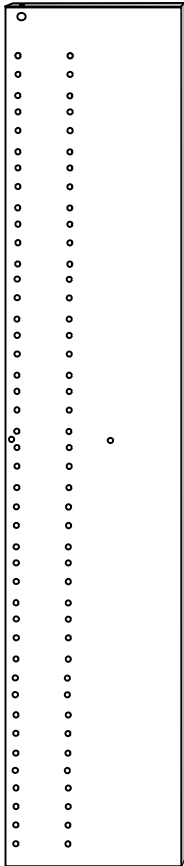
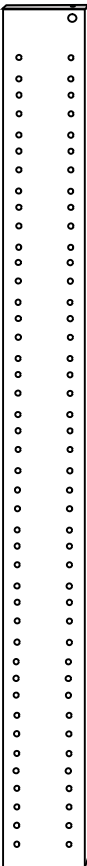
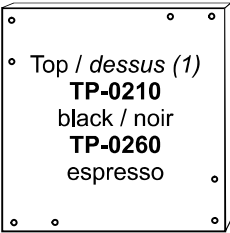
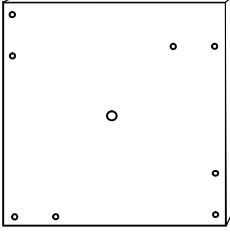
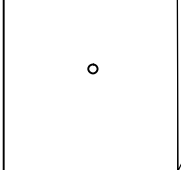
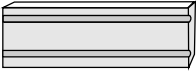
Tower Parts (Box A) <i>Pièces de la tour (Boîte A)</i>	Tower Parts (B) <i>Pièces de la tour (B)</i>
 <p>Left Side (4) <i>côté gauche</i> SL-0212 black / noir SL-0263 Espresso</p>  <p>Right Side (4) <i>côté droit</i> SR-0212 black / noir SR-0263 espresso SR-0222 oak / chêne</p>	 <p>Top / <i>dessus</i> (1) TP-0210 black / noir TP-0260 espresso</p>  <p>Bottom / <i>le bas</i> (1) BT-0210 black / noir BT-0260 espresso</p>  <p>Base / <i>la base</i> (1) BA-0210 black / noir BA-0260 espresso</p>  <p>Adjustable Shelves (36) <i>Tablettes ajustables</i> SH-0211 black / noir SH-0261 espresso</p>

Hardware for Tower A *Quincaillerie pour l'assemblage (Boîte A)*

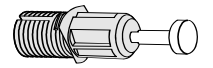

Blue Rapid Rod (8)
Tige rapide bleu
RM-0583

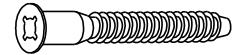

2" Confirmat Screws
Vis Confirmat 2" (16)
RM-0001

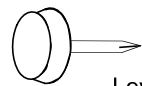

Levelling Feet (4)
Patins à clouer
RM-0139

Hardware for Swivel Base *Quincaillerie pour la base (Boîte B)*

RM-0551

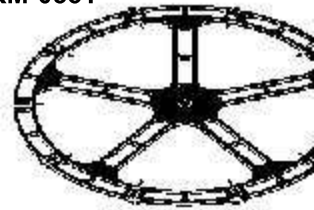

Swivel Mechanism for Base (1)
Mécanisme rotatif de la base

Tools Needed / Outils nécessaires

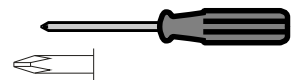

Phillips Screwdriver
Tournevis à pointe cr



If you have any missing parts, please call: 1-877-PREPAC1 (1-877-773-7221) Mon - Fri 7:00am to 4:30pm Pacific Time (10:00am - 7:30pm Eastern) or Please have your product series number available (listed above). Or visit www.prepacmfg.com

Si des pièces sont manquantes, veuillez téléphoner au 1-877-PREPAC1 (1-877-773-7221) lors des heures suivantes: LUN - VEN 7h à 16h 30, heure du Pacifique (10h à 19h 30 heure de l'Est). Veuillez noter le numéro de série avant de téléphoner (voir ci-dessus). Ou visitez www.prepacmfg.com. Pour le service en français, contactez s'il vous plaît votre détaillant.

DATE CODE

1. Insert Cams into Left and Right Sides (4 of each)
Insérez les ferrures dans les côtés gauches et droits (4 de chaque côté)

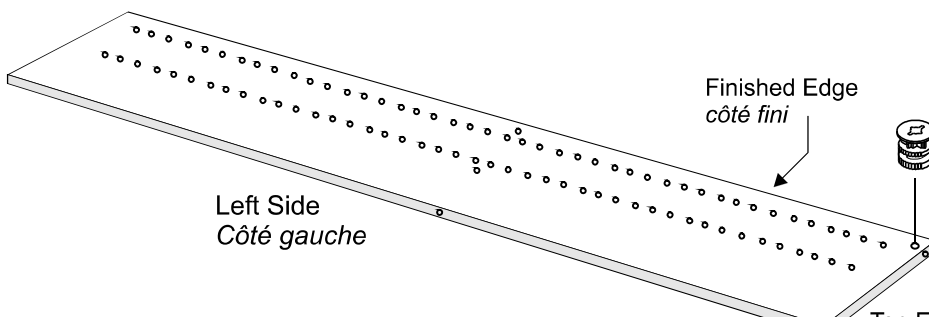

Insert cams in the **unlocked** position, opening facing toward the hole for the rod.
Insérez les ferrures dans la position déverrouillée, de façon à ce que l'ouverture soit face au trou de la tige.

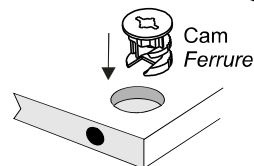

- 6.** Hammer Tack Glides into the unfinished side of the **Base**
À l'aide d'un marteau, enfoncez les patins à clou du côté non-fini de la base.

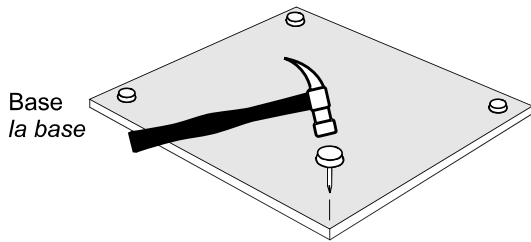

- 7.** Insert plastic plug into hole on the unfinished side of the **Bottom**
Insérez les pièces de plastique dans les trous sur le côté non-fini du bas.

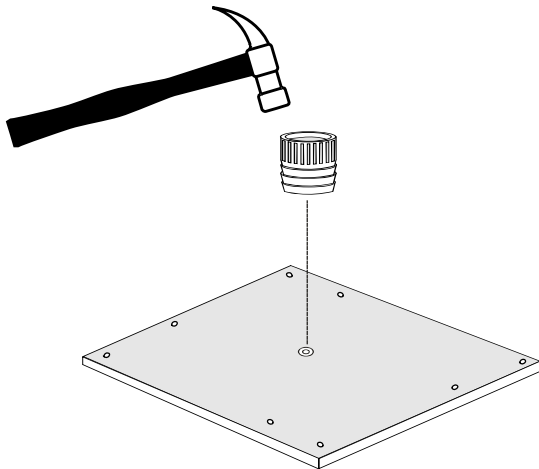

- 8.** Attach Bottom with Confirmat Screws
Posez le bas à l'aide des vis Confirmat

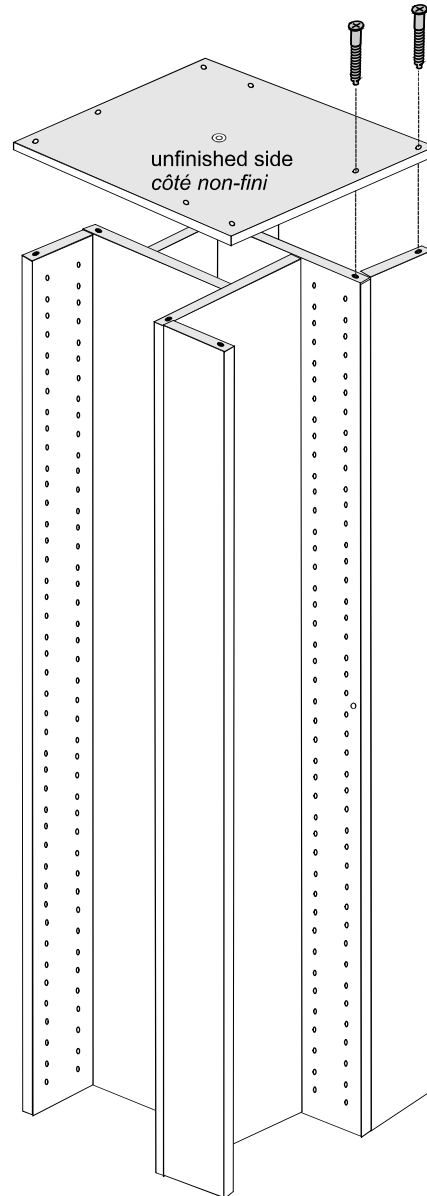

- 9.** Attach
Posez

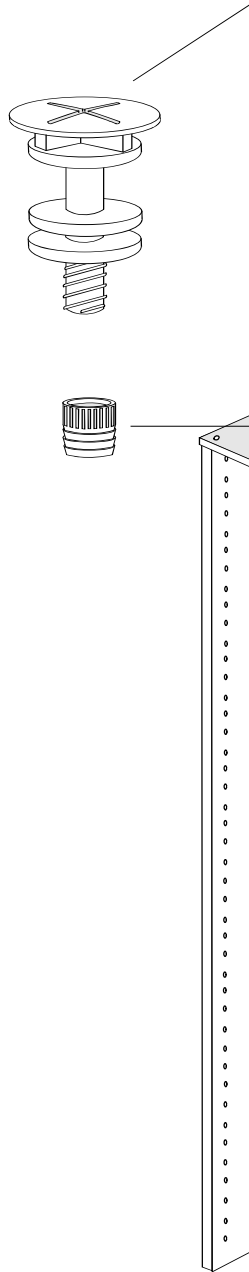

- 10.** Insert **blue rapid rods** into the underside of the top
Insérez les tige rapide bleu dans le côté non-fini du dessus

