

OFFICE CHAIR ASSEMBLY INSTRUCTION

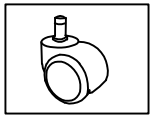

THANK YOU FOR PURCHASING OFFICE CHAIR
HC-6020

PARTS LIST



A 5×Wheels

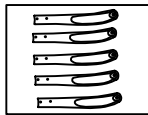

B1 5×Split base tube

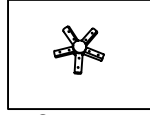

B2 1×Central
base tube



B3 1×base cover

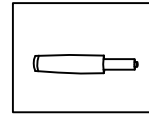

C1 1×gas lift

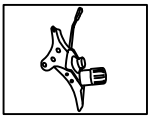

D1×mechanism



E 1×seat



F 1×back

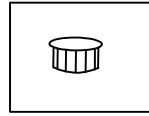

G 8×Plastic caps

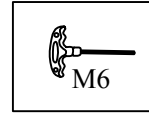

H 1×allen key
M6

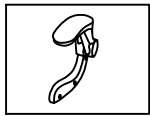

I 1 Left armrests

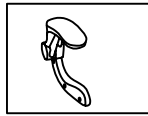

I2 Right armrests

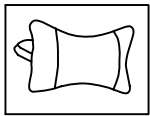

J 1×Pillow

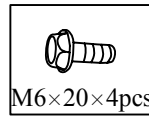

M6×20×4pcs
Z 8 4×screws

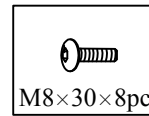

M8×30×8pcs
Y 1 8×screws

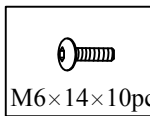

M6×14×10pcs
Z2 10×screws

WARNING

- Do not stand in this chair or use the chair as a step ladder use it as chair only.
- This chair is designed for one person to use at a time.
- This chair is designed for one person weighing up to 250lbs(113kgs).
- Do not use this chair unless all bolts, screws and knobs are firmly secured.
- Check all bolts,screws and knobs every 90days. Tighten if any are loose.
- Failure to follow these instructions may result in serious injury or death of yourself and people around you.
- Some of the part are heavy and/or has shape edge, please install it carefully to avoid hurt you and people around you.

1

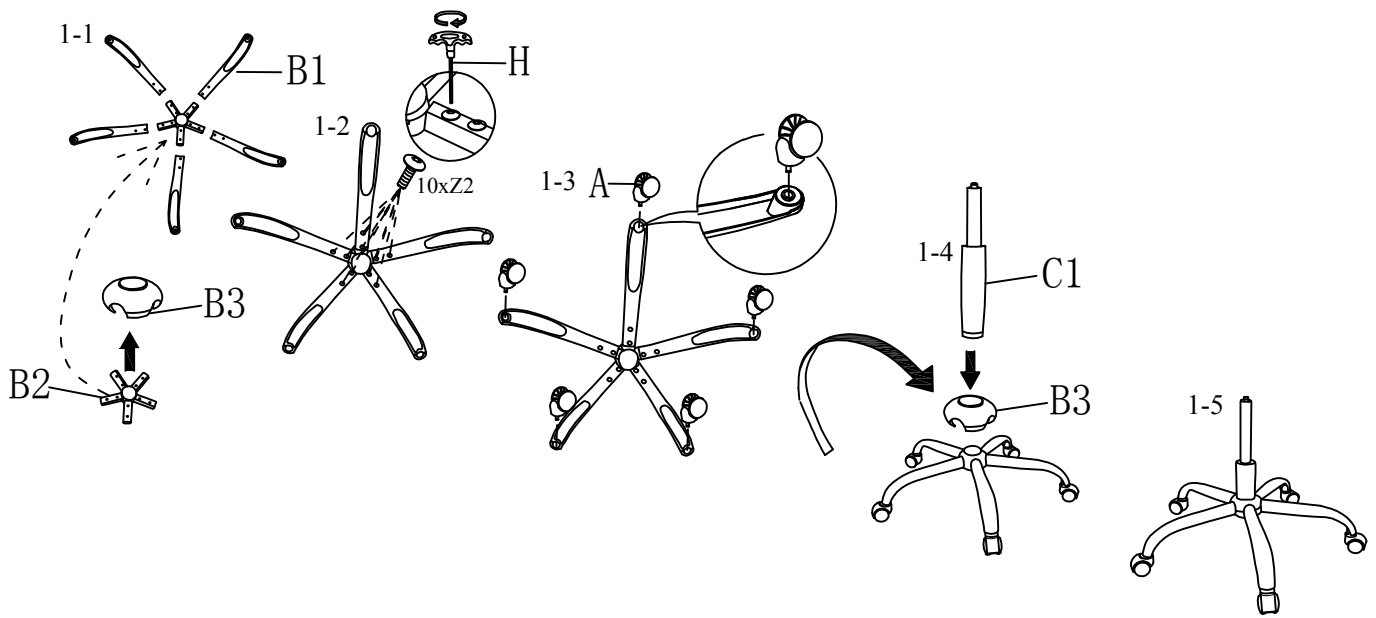

2

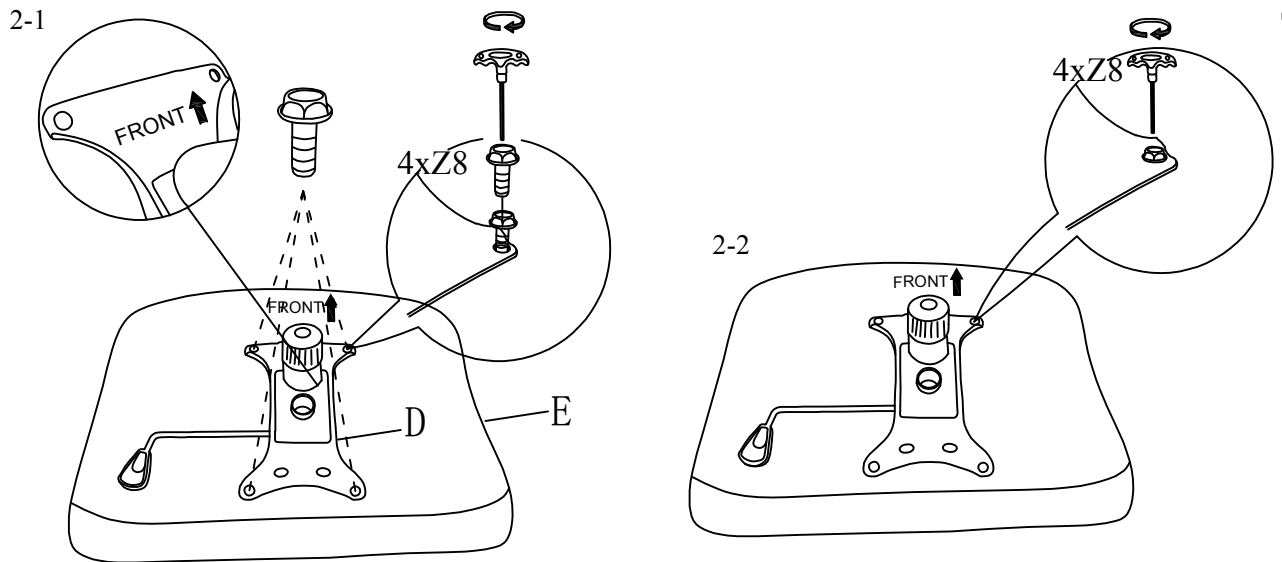

Please do not tight the screw until all screw lined up with hole and try to tight it loosely initially in all screws then tight a little bit more in all screws do not overnight one screws that will make other screw hard to tight but tight all screw firmly in the end

3

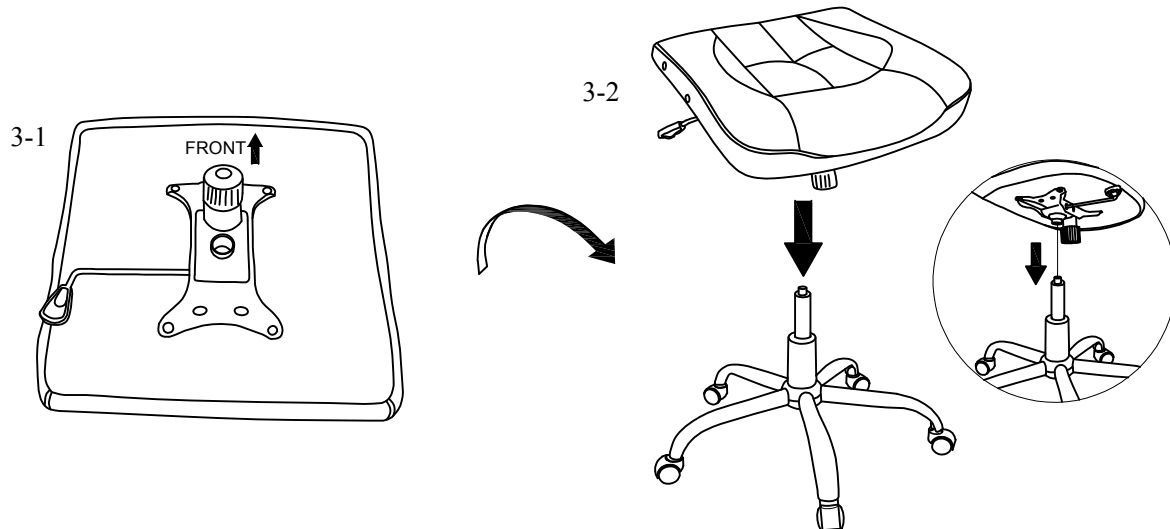

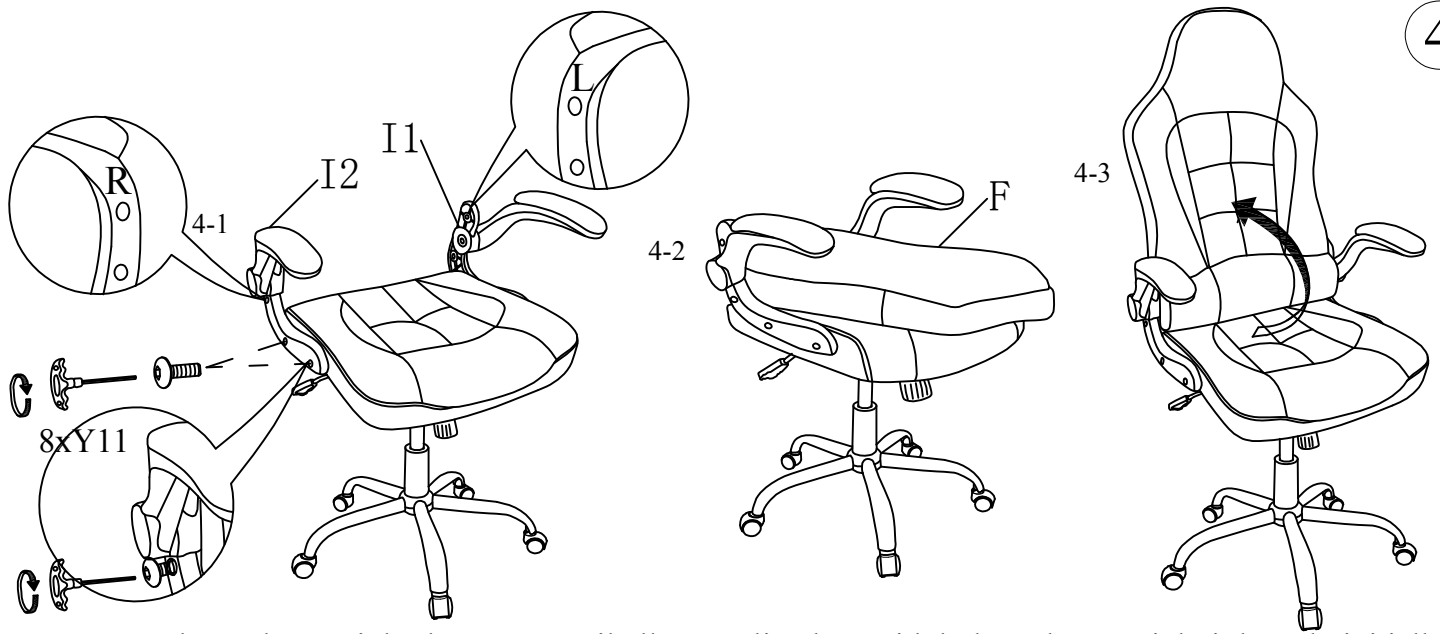

Please do not tight the screw until all screw lined up with hole and try to tight it loosely initially in all screws then tight a little bit more in all screws do not overnight one screws that will make other screw hard to tight but tight all screw firmly in the end

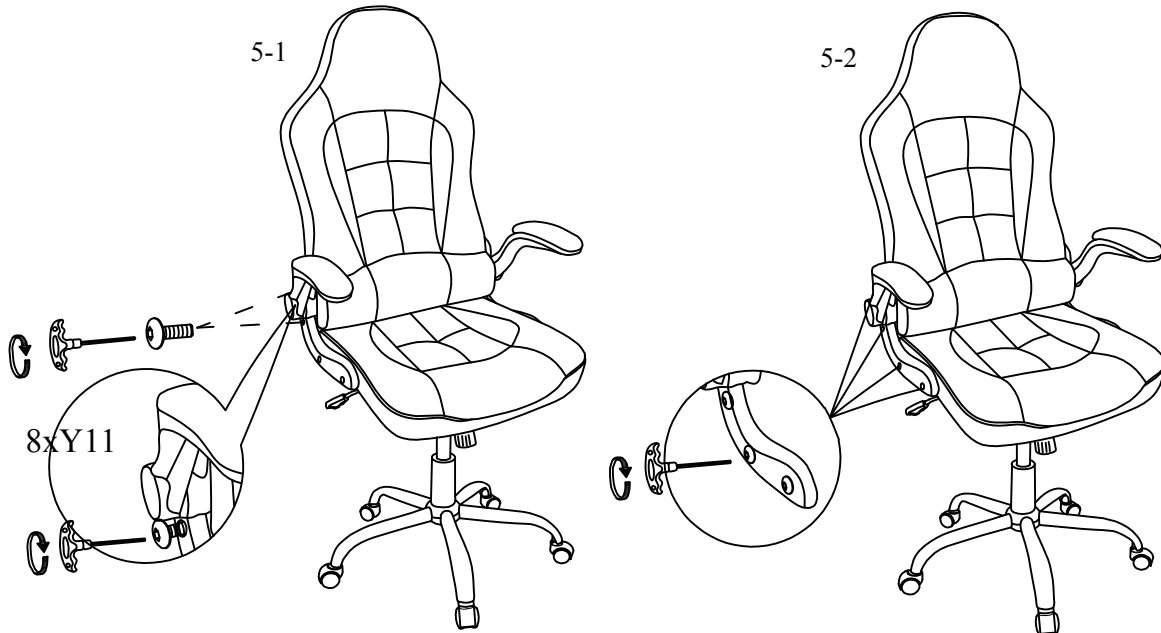

Please do not tight the screw until all screw lined up with hole and try to tight it loosely initially in all screws then tight a little bit more in all screws do not overnight one screws that will make other screw hard to tight but tight all screw firmly in the end

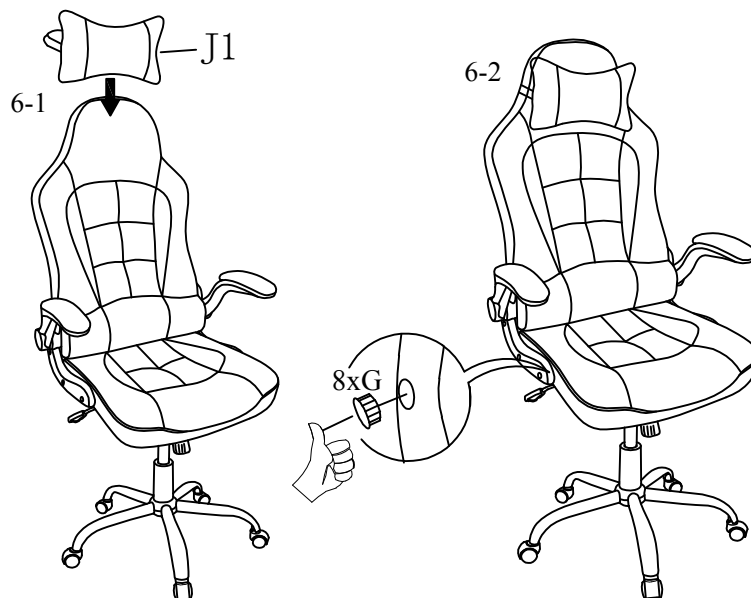

7

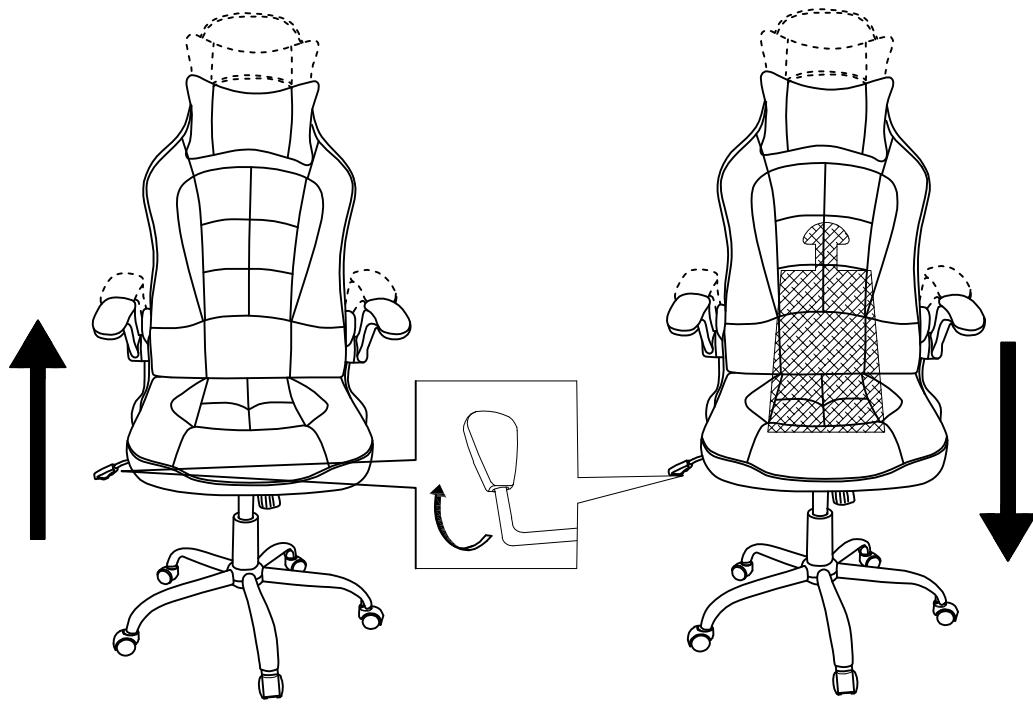

8

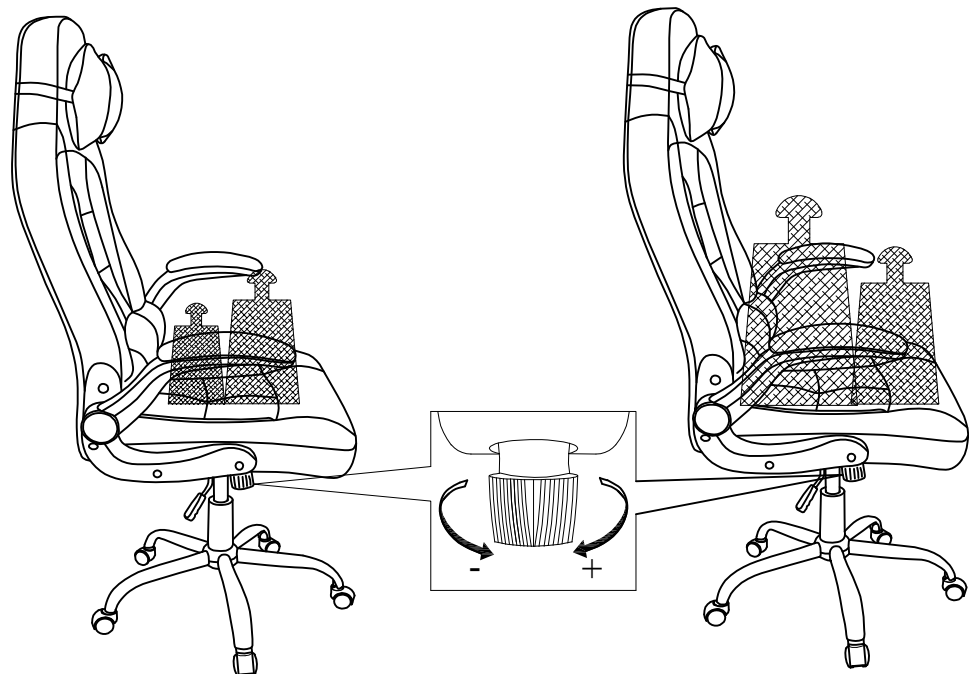

There's a circle under the chair if you turn it, it will lessen the force required to the lean back in the chair

9

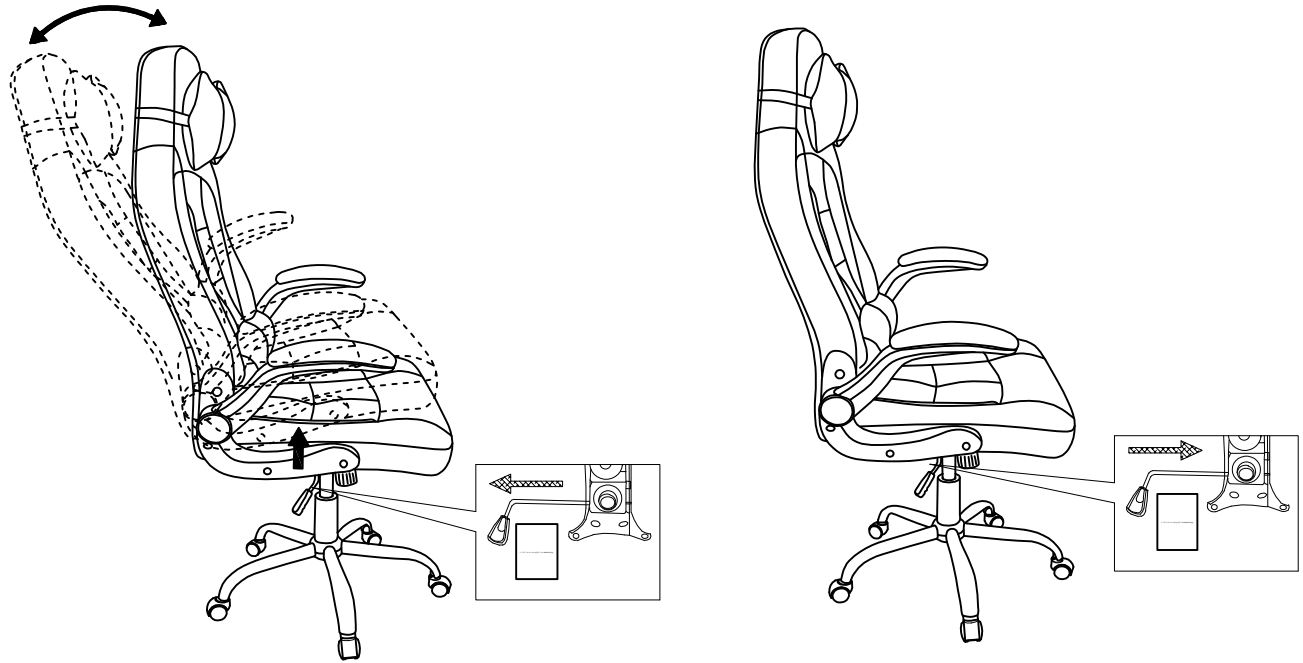

This chair will not lay flat but can recline. in order to recline. please pull the handle on the side out