

OFFICE CHAIR ASSEMBLY INSTRUCTION

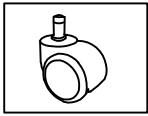

THANK YOU FOR PURCHASING OFFICE CHAIR
HC-6022

PARTS LIST



A 5×Wheels

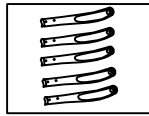

B1 5×Split base tube

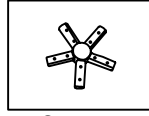

B2 1×Central
base tube

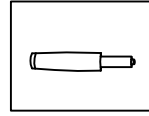

C1 1×gas lift

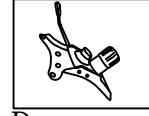

D 1×mechanism

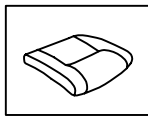

E1×seat

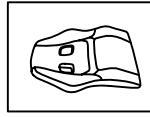

F 1×back

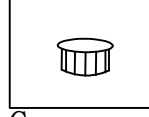

G 8×Plastic caps

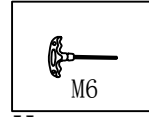

H 1×allen key
M6

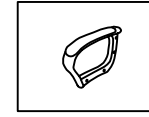

I1 Left armrests

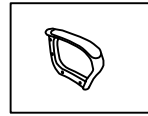

I2 Right armrests

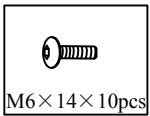

M6×14×10pcs
Z2 10×screws

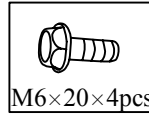

M6×20×4pcs
Z8 4×screws

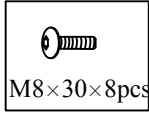

M8×30×8pcs
Y11 8×screws

WARNING

- Do not stand in this chair or use the chair as a step ladder use it as chair only.
- This chair is designed for one person to use at a time.
- This chair is designed for one person weighing up to 250lbs(113kgs).
- Do not use this chair unless all bolts, screws and knobs are firmly secured.
- Check all bolts,screws and knobs every 90days. Tighten if any are loose.
- Failure to follow these instructions may result in serious injury or death of yourself and people around you.
- Some of the part are heavy and/or has shape edge, please install it carefully to avoid hurt you and people around you.

1

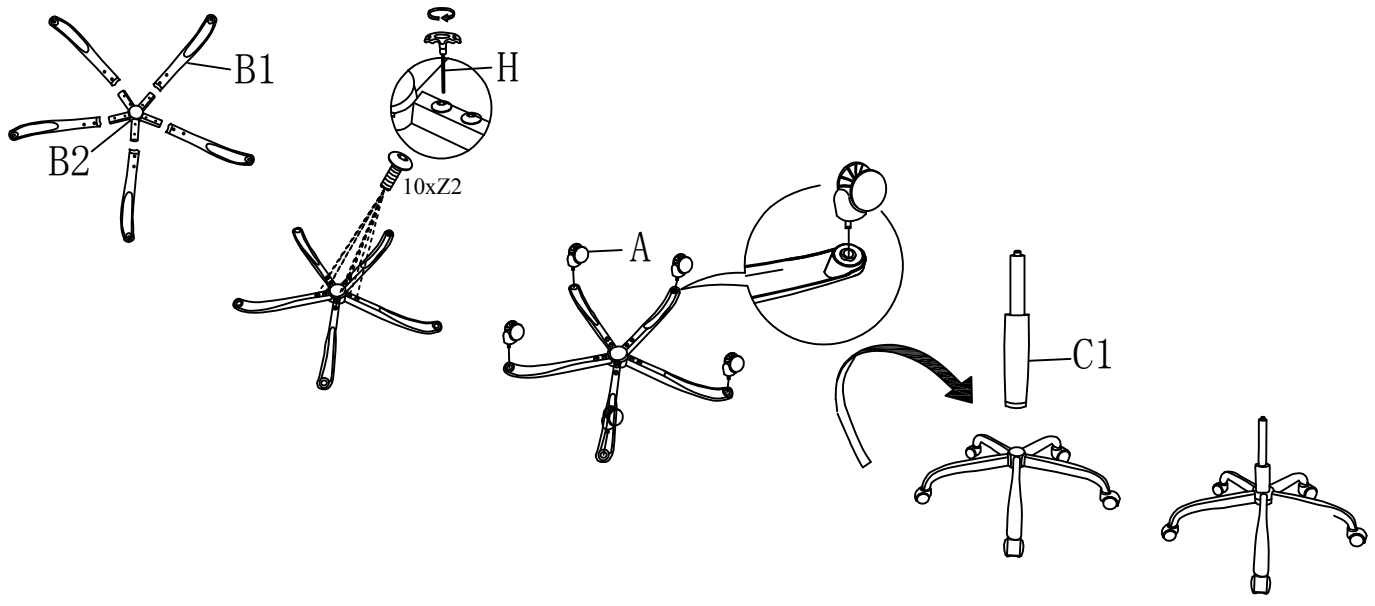

2

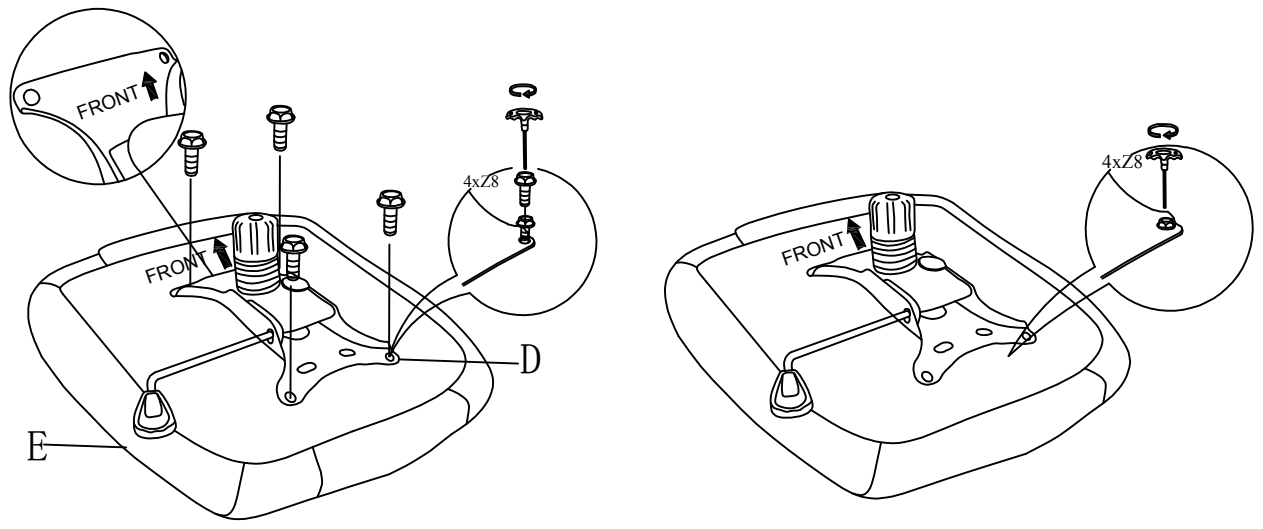

Attention: All the screws in, and then tighten them

3

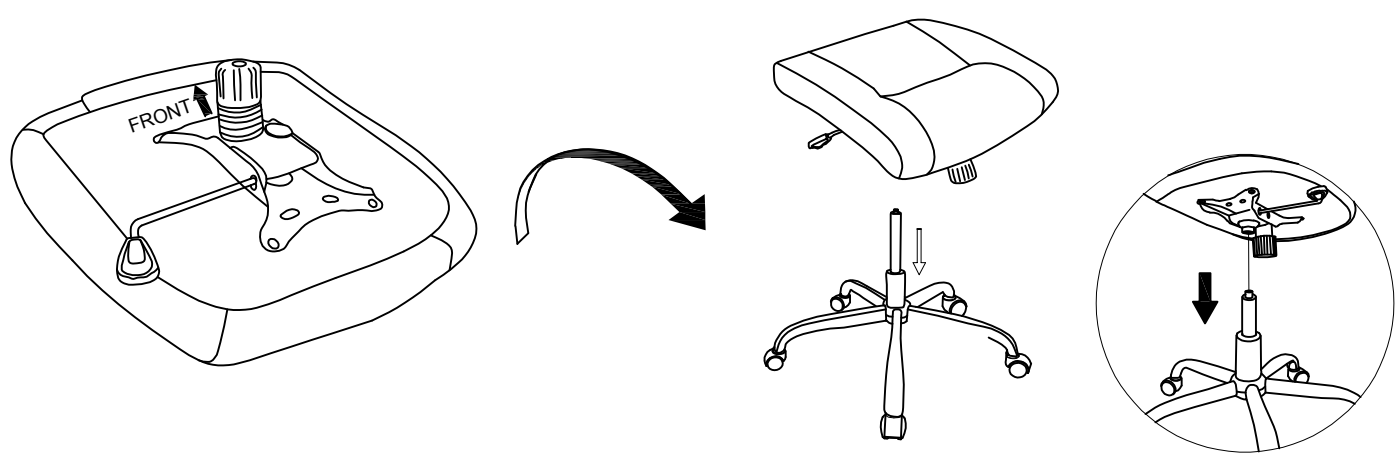

4

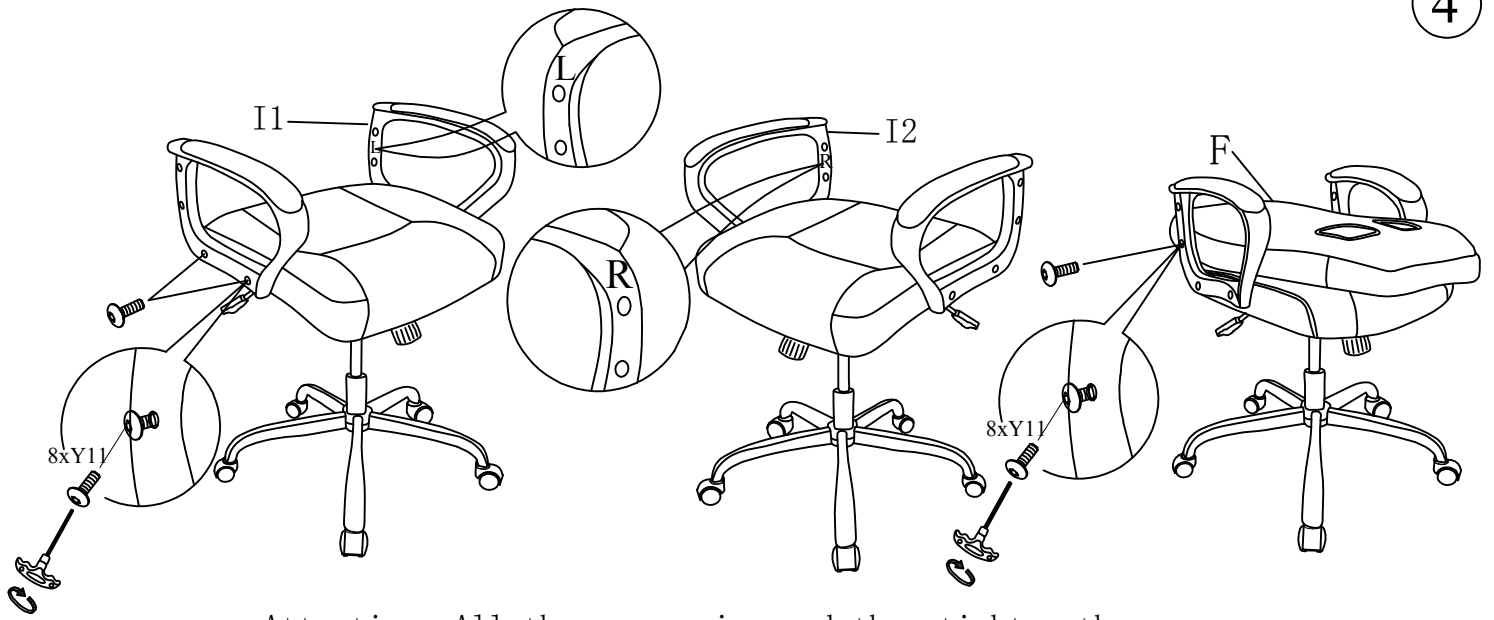

Attention: All the screws in, and then tighten them

5

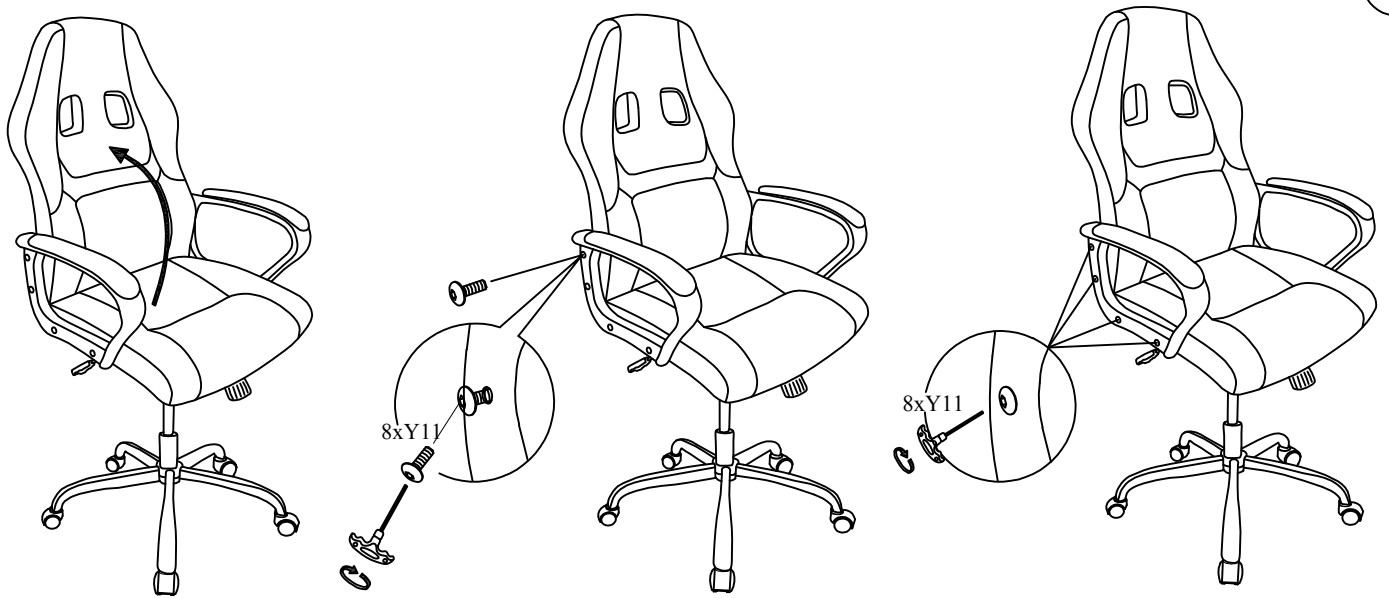

Attention: All the screws in, and then tighten them

6

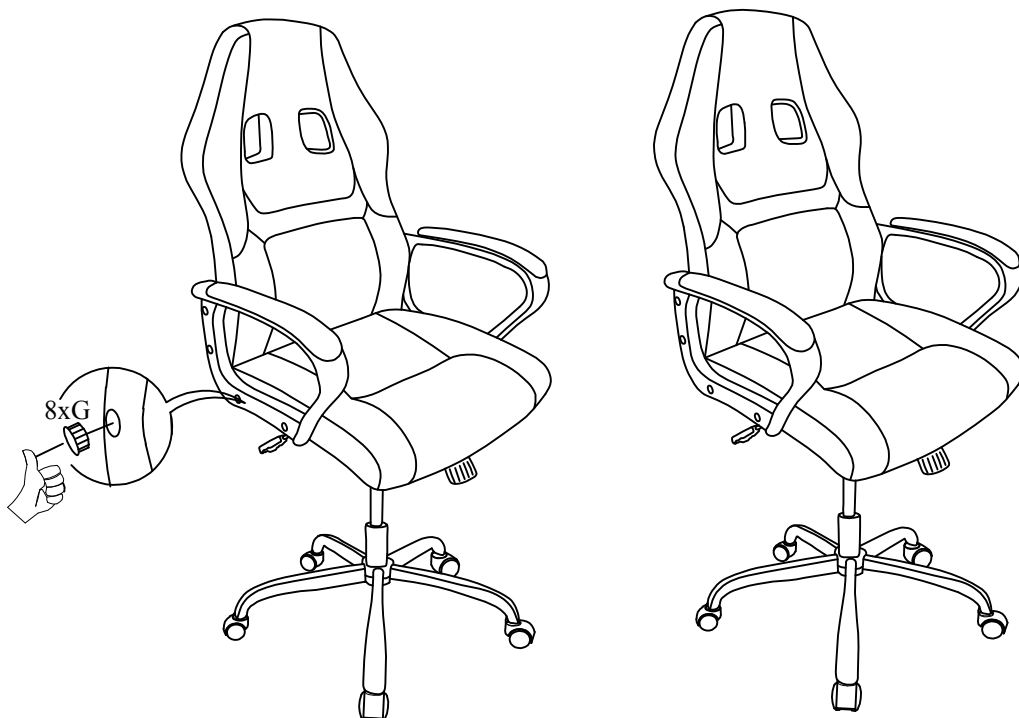

7

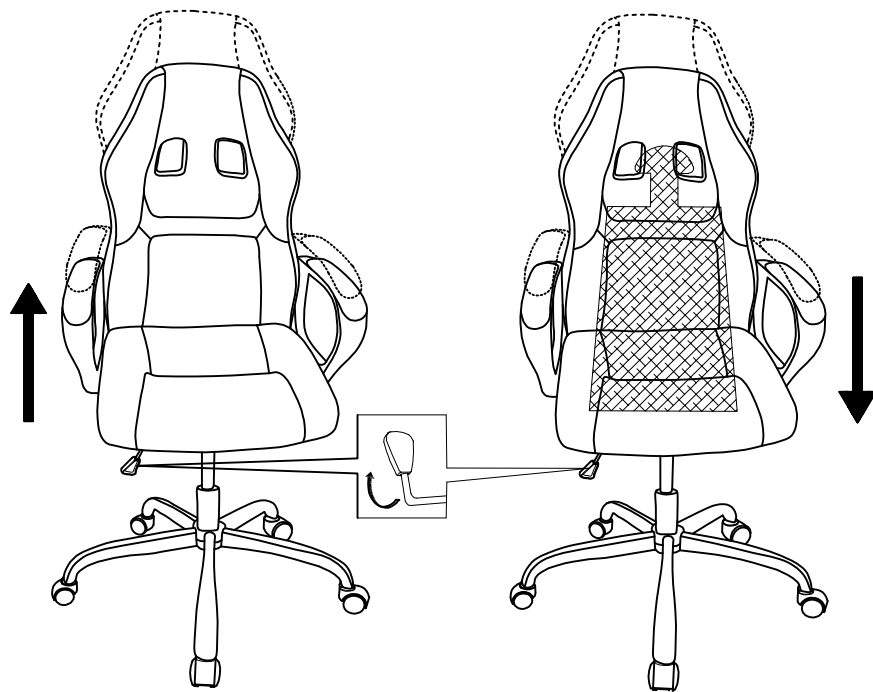

8

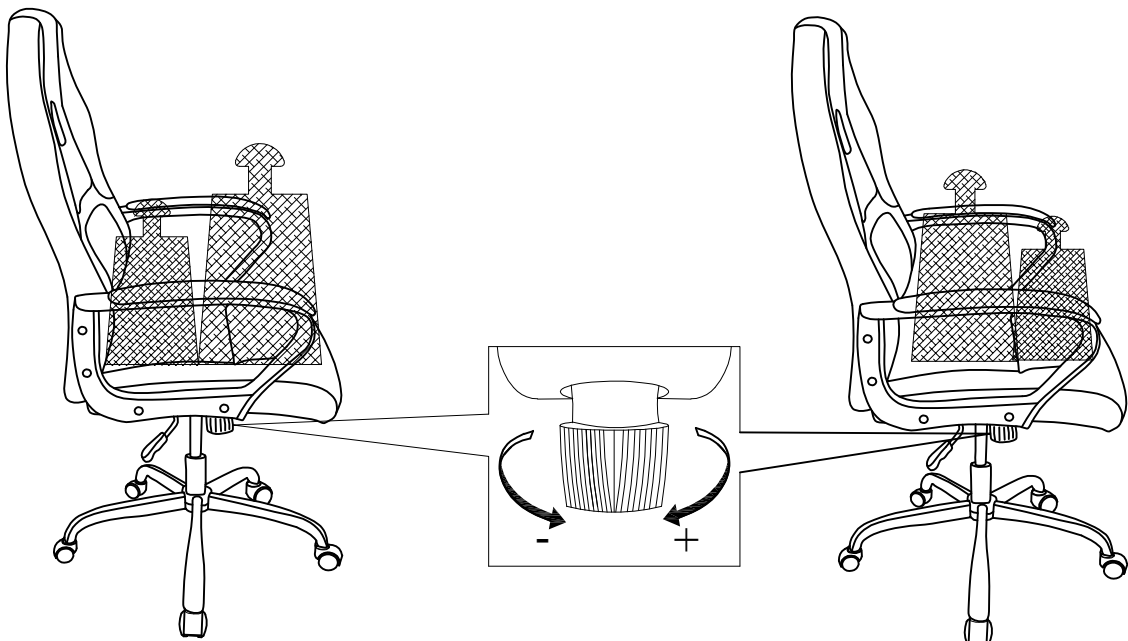

There's a circle under the chair if you turn it, it will lessen the force required to the lean back in the chair

9

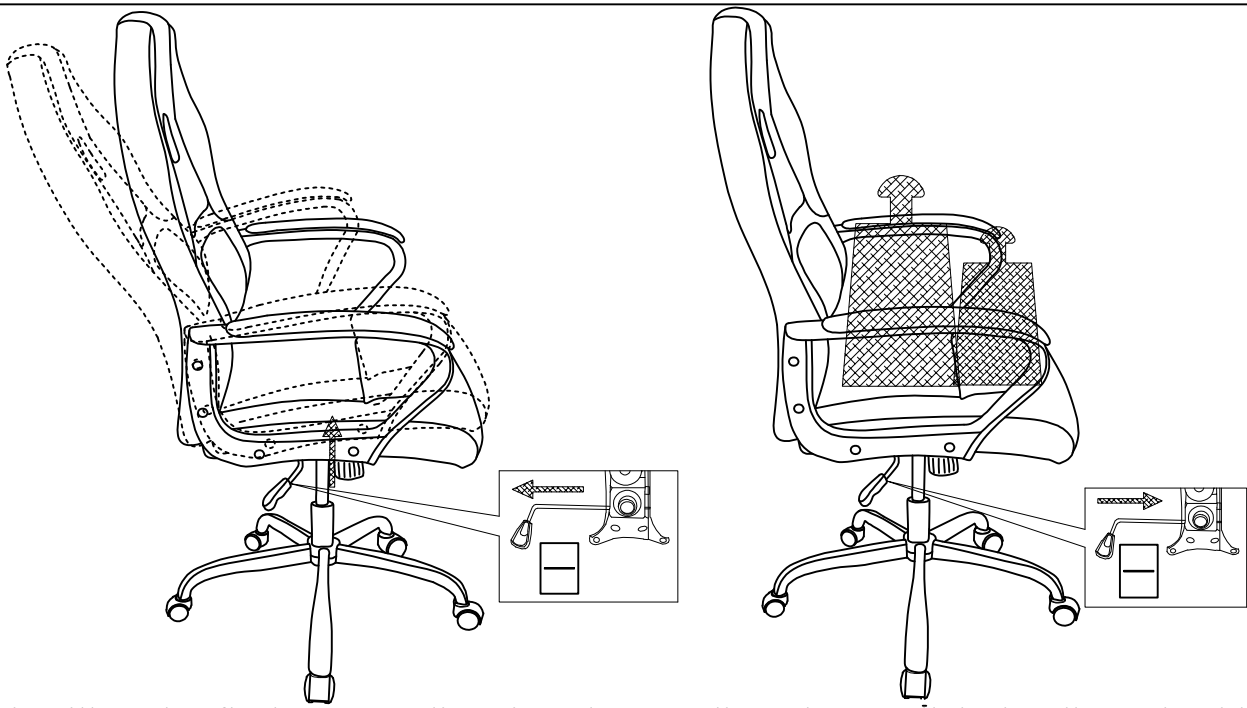

This chair will not lay flat but can recline, in order to recline, please pull the handle on the side out