

ASPEN SIDE CHAIR 8812-02

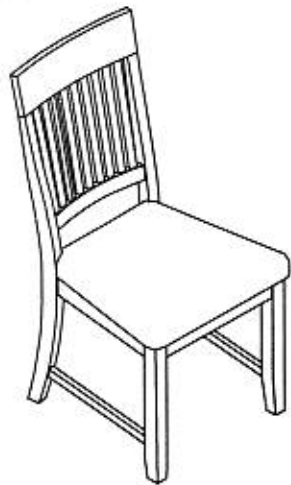

ASSEMBLY INSTRUCTIONS

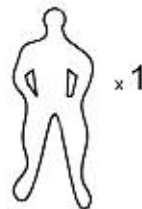

NOT PROVIDED

①



②

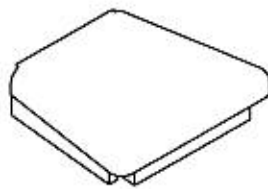

③

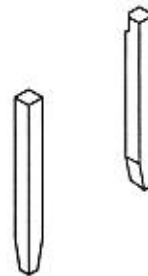

④





NOTE: Do not fully tighten screws and bolts until the entire item is completely assembled

Hardwares

CODE	PICTURE	SIZE	AMOUNT
A		M6 x 50mm	4pcs
B		M6 x 80mm	4 pcs
C		M6 x 40mm	1 pcs
D		Ø6/13	9 pcs
E		Ø8/19	9 pcs
F		Ø4 x 50 mm	4 pcs
G		4mm x 60mm	1pc

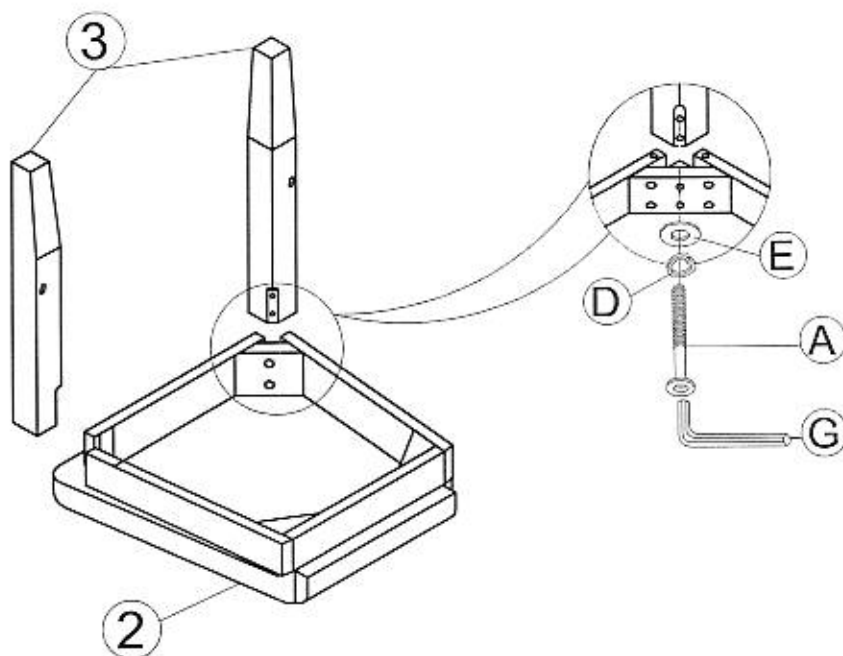





Step-1 Do not fully tighten screws and bolts until the entire item is completely assembled.

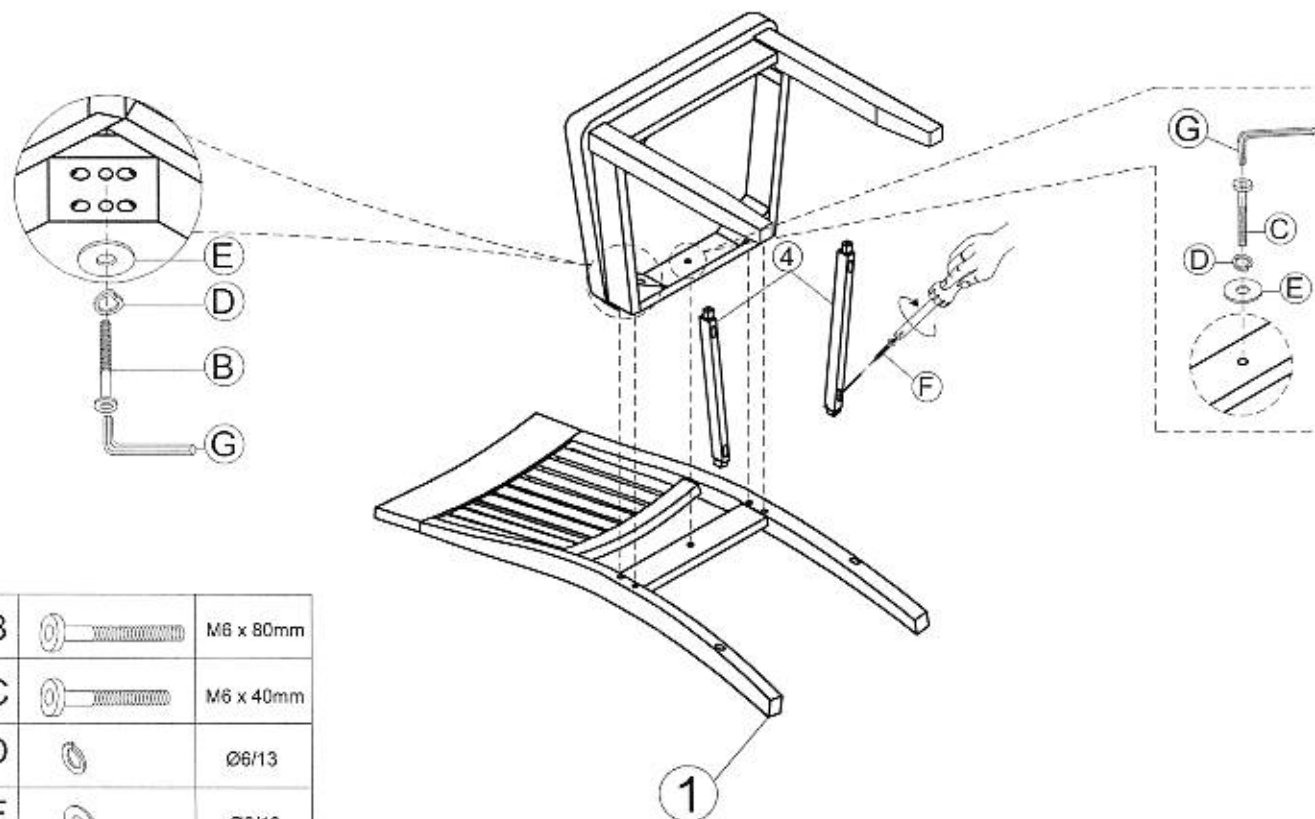

A		M6 x 50mm
D		Ø6/13
E		Ø8/19
G		Ø4 x 50 mm

Step-2



B		M6 x 80mm
C		M6 x 40mm
D		Ø6/13
E		Ø8/19
F		Ø4 x 50 mm
G		Ø4 x 60 mm